



# System Description



# About Time&Space

Time&Space (T&S, TS) is a fully integrated system providing a complete solution for workforce management including access control and working time management. The system is modular with a client-server architecture, offering web access or desktop clients. It operates on Microsoft Windows and is based on either an SQL or Oracle database. The software connects natively to Spica's own Zone series of devices for access control and time recording. Various RFID card and biometric technologies are supported, including fingerprint and iris recognition.

The Time&Space system excels in flexibility and scalability, making it suitable for very different companies and organisations, regardless of their size and geographic spread. The users can be found in every sector from manufacturing, energy and mining to retail, finance, hospitality, healthcare and government.

Spica is a company with years of experience in the field of corporate security and working hours management. Selected references, testimonials and case studies can be found at [www.timeandspace.eu](http://www.timeandspace.eu).

## Scalability

Smaller users can run Time&Space on almost any office computer capable of running the latest Microsoft Office version. The database can be the desktop version of MS SQL or Oracle. Time clocks and access controllers are accessed through the company network.

Larger systems can have unlimited number of time clocks and access points, workstations for time and attendance administrators, unlimited number of smartphone and web access clients. Multiple servers can be used for running data collection, database and application services. All components are connected over the corporate network (intranet).

## Minimum Software Configuration

For small users, an ordinary office PC with the latest MS Windows operating system is sufficient. The minimum software license is for 25 users and one administrator. Oracle or MS SQL desktop database license is free of charge.

# System Architecture

Access control is built upon two basic controller components: the Zone Wing intelligent controller and the Zone Door smart I/O device. Zone Wing carries out the access control logic, holds user access profiles and acts as a hub connecting a number of Zone Door devices. Zone Door connects local peripherals for access control associated for with each access point, such as card readers, door locks, door contacts, alarm triggers, and exit buttons. Zone Wing connects directly to an IP network, either through Ethernet or via wireless or mobile data interface. Each Zone Door connects to a Zone Wing via CAN - a highly robust industrial subnetwork.

The host system manages communication with the controllers in real time (recording events, providing feedback, updating device parameters, handling alarms, etc.). In the event of any loss of communication, the controllers continue to function normally, offline. Once communication is restored, the controllers and host system synchronise automatically. Advanced inter-process signalisation maintains smooth and coordinated operation of the entire system in real time, 24 hours a day without interruptions.

The main application client, Time&Space Manager (TSM), is installed on workstations and offers access to the system's full functionality, including configuration, system administration, and access control management. For day-to-day time management tasks, a web-based service (WebTS) provides deployment-free solution.

Mobile time clocking, management and monitoring of working time is possible through a smartphone application (Spica Mobile Time, iOS and Android), providing the most frequently used functionality for both admins and employees.

The system capacity depends solely on the strength and the performance of the system components (client workstations, network, servers). Due to the modularity of the system components, the expansion of the system is practically limitless.

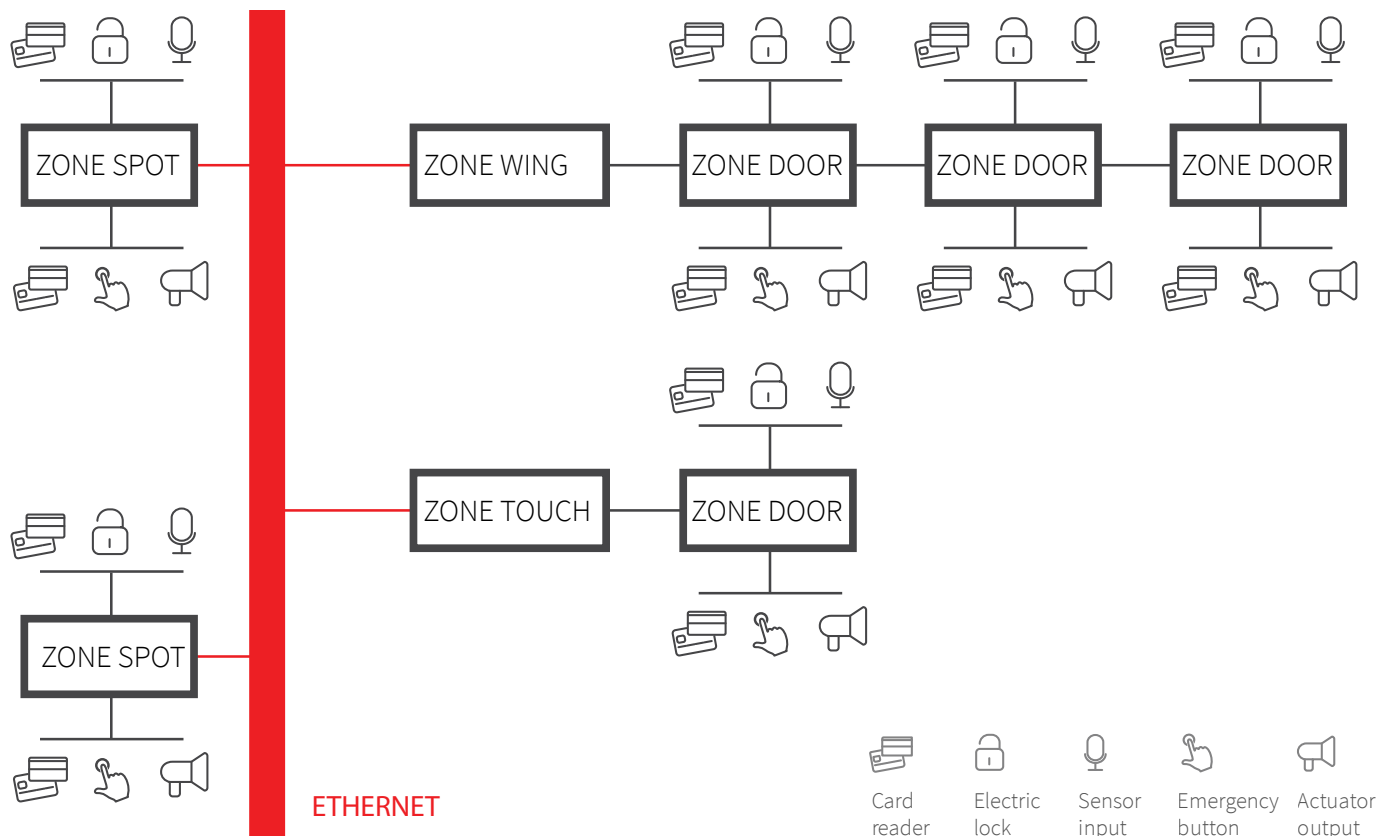

# Zone Access Controllers

**Access control** is based on Spica's own Zone Access device series. The widest range of access control topologies, from "long corridors" to "lone doors" is covered with just three devices, providing excellent per-door economy:

**Zone Wing** is an intelligent IP device capable of offline operation, using the synchronised copy of access rights and rules. It does not provide door I/O, but rather serves as a hub for connecting multiple door I/O devices called Zone Door.

**Zone Door** is a smart door I/O device with ports for connecting usual access control peripherals such as readers, door locks, sensors and actuators. Multiple Zone Door devices are connected via secure subnetwork to one Zone Wing device.

**Zone Spot** contains one Zone Wing and one Zone Door merged into a single device. Zone Spot is an ideal solution for "lone doors", or more precisely, remote access points with up to two doors.



## Zone Touch Time Clock

**Zone Touch** is a compact and streamlined feature-rich time clocking terminal with a backlit colour touch screen and a built-in card reader.

Zone Touch normally operates online, so upon clocking, it will show the employee name, the resolved event name and the employee's current balance of hours. In case of communication dropout, the Zone Touch continues working autonomously until the communication is restored.

Access control can be added simply by attaching a Zone Door I/O device. One external reader can also be connected.



- ⊕ Ethernet Connection
- ⊕ Built-in card reader
- ⊕ Touch screen
- ⊕ Power over Ethernet
- ⊕ Beeper
- ⊕ Door device control
- ⊕ Backlit Colour Screen
- ⊕ Offline Autonomy

## Readers and ID Cards

Time&Space supports a wide range of RFID card technologies and readers, such as HID iCLASS SE® and multiCLASS SE® supporting iCLASS Seos®, iCLASS SE, standard iCLASS®, MIFARE® Classic, MIFARE DESFire® and OSDP protocol. Time&Space also offers support for legacy RFID card technologies such as HID Prox, Indala and EM. Several technologies can be used within the same system, either by utilising hybrid cards or with multi-technology readers.



## Wireless Locks

Time&Space supports wireless locks by the industry leader Assa Abloy. Aperio™ locks are supported for general access control applications. For specialized hospitality applications (hotel systems), Time&Space offers support for Visionline wireless locks.

## Biometric Identification and Verification

Biometric characteristics are unique to each individual, and biometric identification can be very reliable, efficient, and convenient. The possibilities for abuse are significantly reduced as the risk of stolen or borrowed cards is practically eliminated. Security can be further enhanced by combining two or even three factors of authentication.

Time&Space offers carefully selected biometric technologies developed by the world-leading manufacturers. Fingerprint and iris recognition are available as standard, and other biometric technologies can be supported upon request.

Every biometric system relies on biometric “templates” which are enrolled in advance and later used for comparison. The templates can be stored in the database and distributed to the individual readers. Alternatively, they can be stored on ID cards, offering better privacy and requiring less central management. Time&Space offers a range of template management options, depending on the user requirements, preferred management method, and the choice of readers and cards.



## Important Note

In some countries, the use of biometric technology is regulated. It is therefore important to understand the local regulations before making decisions on how to implement biometric technology.

# Time&Space Software

An important feature of the Time&Space software is its modularity, which leaves the customer free to choose additional components at any time and to upgrade the system later, as and when required.

Optional SDK's, API's and utilities make the system ideal for the 3rd party integration, allowing a high level of interoperability with other applications and systems.

Much attention has been devoted to the design of the graphically-rich user interface, which offers strong data visualisation and data manipulation. The available views enable large amounts of data to be displayed quickly and clearly, allowing fast and easy comprehension and navigation. The built-in report manager allows users to craft their own report content and layouts. The report manager is accessible from many views within the system. The system offers a full menu of predefined reports which can also be customised.

Access to the software is protected by individual and role-based authorisation, with structured rights, ensuring easy and efficient rights management. Centralised authentication is supported through Microsoft Active Directory. Time&Space can also be configured to support native database authentication, either Oracle or MS SQL.

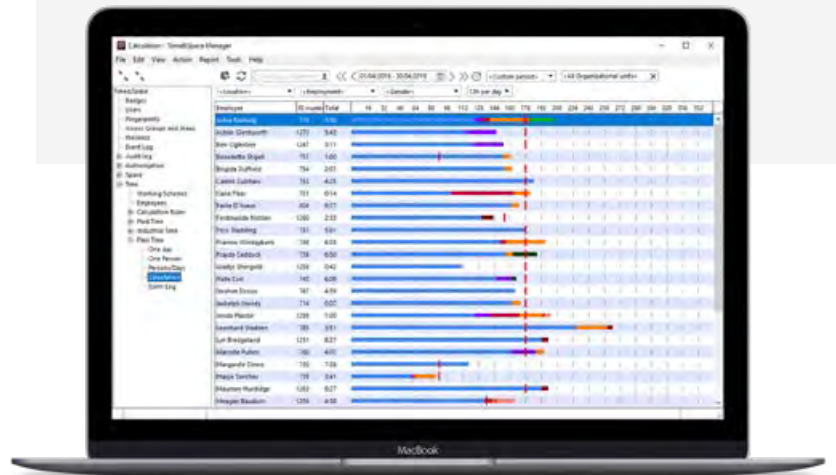
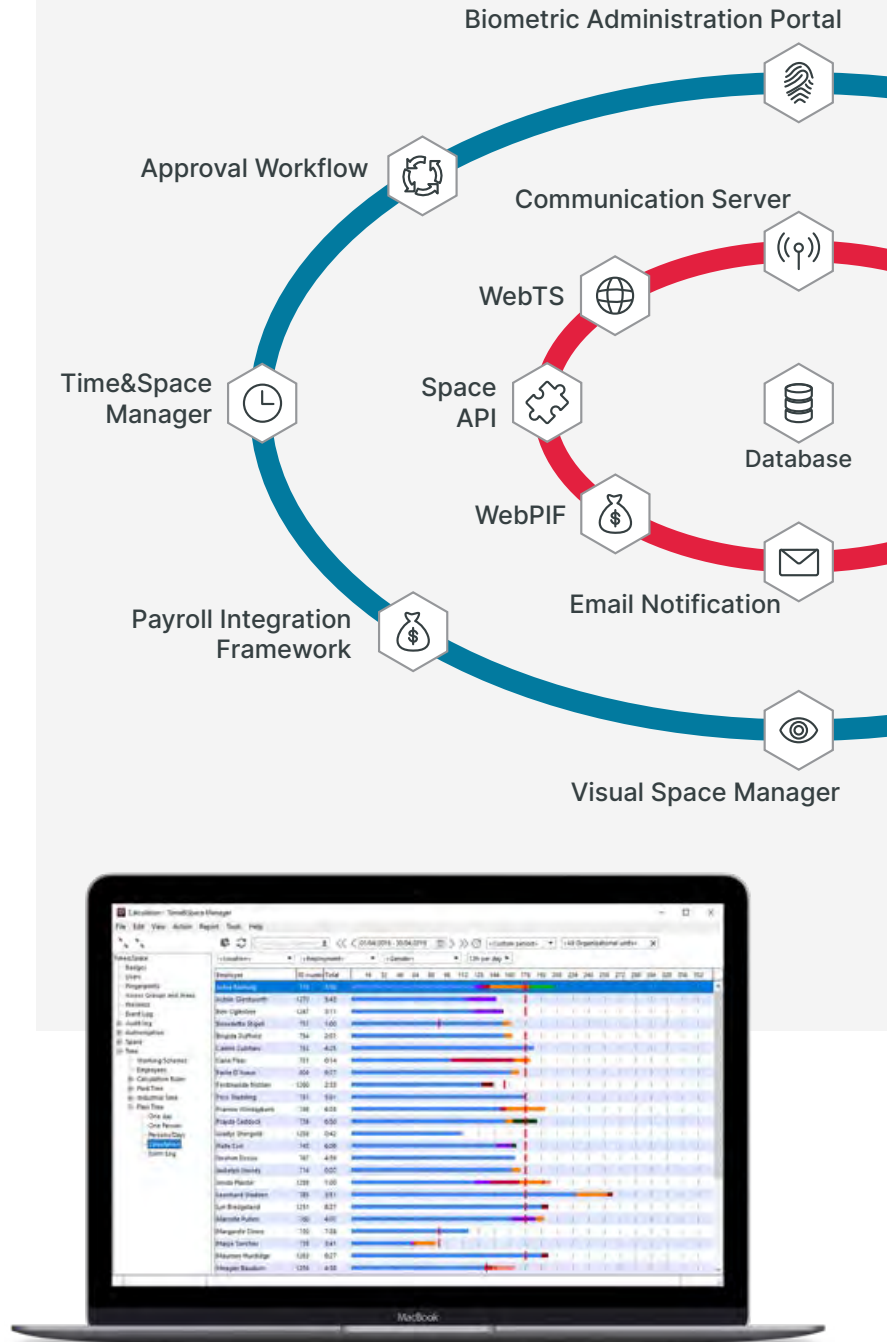

- ⊕ Real-time communications
- ⊕ Oracle & MS SQL
- ⊕ Report Generator
- ⊕ Easy Localisation
- ⊕ Contextual Online Help
- ⊕ Biometric Template Mgmt.
- ⊕ Approval Workflow
- ⊕ Video Surveillance Integration
- ⊕ Active Directory support
- ⊕ Data Visualisation
- ⊕ Real-Time Calculation
- ⊕ Audit Trail
- ⊕ Smartphone Access
- ⊕ Data Export & Import
- ⊕ Browser Access

# Software Components

The software is based on two main components: Time&Space Manager (TSM), a desktop client for the configuration of time management and access control functionality, and Device Administration Portal (DAP), managing the communications and device configuration. The additional modules WebTS (web version of Time&Space Manager) and Spica Mobile Time (mobile application) ensure system availability from anywhere. Other components are intended for the system's additional functions and integration with other systems.

**Time&Space Manager (TSM)** is the main software client for the operation of individual application modules based on the selected configuration (access control, time and attendance, reception desk, etc.). It is generally used by the main system administrators for higher-level system management.

**Device Administrator Portal (DAP)** manages the data exchange with access controllers and clocking terminals. It is also used for configuring the event collection and communication control and for real-time system monitoring. Once set up, it operates autonomously without the need for operator intervention.

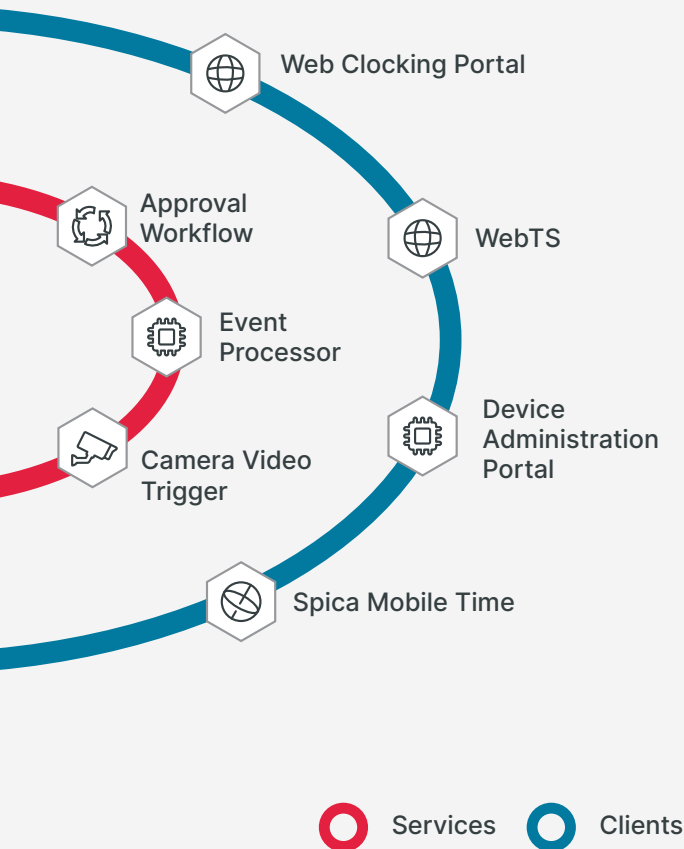

## Additional Components

**Web Time&Space (WebTS Server)** provides web access for various core time management tasks, such as the viewing and editing of employee time data, recorded events, schedules and also various time management functions. Different access levels to data and functionality, depending on the user's rights and requirements is managed through the TSM.

**Payroll Integration Framework (PIF)** is a module which takes working time data and turns it into calculated and normalised input for payroll purposes. The module offers a number of predefined and customisable data transformations. A system of custom-built software plugins is available for solving special requirements. Web access is also available.

**Biometric Administration Portal (BAP)** is a web application for biometric template management within the Time&Space system, such as capturing and distribution of biometric templates and template acquisition from remote readers.

**Approval Workflow (AW)** is a web-based module providing a managed workflow of requests and responses for time & attendance management. It handles the approvals for annual leave, business trips, overtime, balance corrections, and other absence and presence situations. AW supports multi-level approvals and other advanced features.

**Spica Mobile Time (SMT)** is a smartphone app for remote clocking and simple work-time management tasks. Employees can review their history and submit absence requests. Managers can monitor the attendance records of their team in real-time, identifying exceptions and managing approval workflow requests.

**Spica Field Clocking (SFC)** is an Android app for clocking teams of employees on a single mobile device. Identification can be with fingerprints (Safran Morpho tablet) or employee cards (any device with the NFC reader).

# Access Control

Access control is the underlying framework for the entire Time&Space system, keeping track and managing users, cards, access points and events. Access control is performed according to the user access profiles which define who-can-go-where-when.

Another function of the access control is setting up and handling of alarm events triggered by the access control peripherals. Alarms can be monitored, acknowledged, disabled and acted on in real time.



## Visual Monitoring

Visual Space Manager (VSM) provides the front-end for the access control system. VSM screens feature graphical, real-time representation of Time&Space events using maps, floorplans or even aerial photos. Events are displayed as a scrolling list and/or as pop-up alerts on the graphical display. VSM can trigger audio alarms for individual event types (i.e. fire alarms) and send text messages or e-mails. VMS can be integrated with 3rd party Central Monitoring Systems (CMS).

## Video Surveillance Integration

Time&Space system also offers integration with Milestone's renowned XProtect video surveillance platform, supporting the widest variety of IP video cameras. The integrations link access control events and video recordings, allowing cross searches between the two.

## Visitor management

Time&Space reception module is called Front Space (FS) and provides visitor control and record management. Visitor access control and visit tracking are based on assigning temporary identification cards with optimised access profile options. The module supports advance booking of visits and provides views for currently-active and completed visits.





# Industrial Time

Designed for use in factories, plants, workshops and other environments with fixed shifts. Working time is determined by daily schedules defining default time, two breaks, default check in/check out times, and the threshold of overtime. The focus of working time management here is on monitoring deviations from planned schedules and the efficient management of overtime. Various parameters for accommodating special rules are supported; for example those setting the day plan, day limit, the limit of shift extension and the "arrival window". The latter is used for automatic selection of the shift scheme on the basis of recorded arrival time (or even the departure time), which is just one of the methods available for determining the schedule for the day. Industrial Time supports recording and calculation of business absence, business trips, sick leaves, leaves of absence and vacations.

Categories of working time and associated events are user definable. The module includes automatic calculation of remaining vacation days, a calendar with holidays and working days.

Calculation Type	Flexi time	Industrial time	Paid time
Arrival, departure	•	•	•
Holidays	•	•	•
Holiday bonus	•	•	
Private exit, Sick leave	•	•	
Business exit / trip	•	•	
Vacation, vacation quota	•	•	
User events	•	•	
Hours balance	•		
Overtime	•	•	
Paid, unpaid time	•	•	•
Core time violation	•	•	
Day / current balance top	•		
Day limit	•		
Shifts	•	•	
Holiday / weekend hours	•	•	
Daily / weekly schedules	•	•	•
Working scheme	•	•	•
Work plan	•	•	•
Dynamic scheduling	•	•	
Jobcosting	•	•	

# Automatic Planning

Both Industrial and Flexi modules include several levels of automatic planning. Daily and weekly planning is handled by time schedules, while longer planning periods are managed using work schemes and plans with advanced shift patterns and an automatic selection of schedules based on pre-set rules.

# Job Costing

Advanced time management allows tracking of working time by project, task or point of origin (place). Any of these may be used as cost centre for job costing. A frequent job costing event can be associated with a time clock key, eliminating the need for time-consuming numeric entries.



# Reports

A broad choice of predefined reports is intended not only for management and administration purposes, but also for users' better insight into their working time. Reports can be made for any chosen period of time, sorted, filtered and then grouped according to various criteria, such as organisational units.

The main report or summary report is the most comprehensive and contains the overview of all categories of working time in the chosen period, deducted hours (due to various restrictions), and comparison between planned and actual attendance. This report provides a thorough insight into the working time calculation including the analysis of the working time structure by categories, divided between workdays, public holidays, weekends, etc. The main report can be also exported in various table formats for further processing (payroll).

There are also reports focusing on a particular category of working time. These can be listed by days, weeks or months, which enable the user to review the statistical report for any chosen period. The user can review the content of the existing schedules as well as the plan of their usage, all violations of the worktime rules, attendance and absence at specified time or time interval, balance of hours, complete list of events and manual entries for one or several employees.

Various reports are also available for access control system functions. Reports can be exported in Microsoft Excel (XLS), Adobe Acrobat (PDF), Rich Text Format (RTF), Web Page (HTML), JPEG and Bitmap image (BMP) formats.

## Preset reports:

- |   |  |   |
|---|--|---|
| <input type="checkbox"/> <b>Balance of hours</b>            | <input type="checkbox"/> <b>Attendance</b>             | <input type="checkbox"/> <b>Free period From - To</b> |
| <input type="checkbox"/> <b>Violations &amp; Exceptions</b> | <input type="checkbox"/> <b>Personal data</b>          | <input type="checkbox"/> <b>Events</b>                |
| <input type="checkbox"/> <b>Schedule plan</b>               | <input type="checkbox"/> <b>Any view report</b>        | <input type="checkbox"/> <b>Summary report</b>        |
| <input type="checkbox"/> <b>Time categories</b>             | <input type="checkbox"/> <b>Per day, week or month</b> | <input type="checkbox"/> <b>Absence</b>               |

# Integration

Time&Space offers several levels of integration with 3rd party applications. There are tools for importing and exporting static data, and exporting events and calculations. Most reports can be exported and used for further processing.

Integration module called Payroll Integration Framework (PIF) is available for advanced post-processing of time&attendance data, payroll data adaptation and for providing data links to company HRM and ERP systems. PIF's plug-in capability allows rapid development of tight integration solutions according to individual customer needs.

For developers, Time&Space SDK provides APIs for the ultimate level of integration, for both access control (SpaceAPI) and time and attendance (TimeAPI).

# Business Intelligence

Time&Space database contains specialized set of normalised tables which are maintained specifically to be used with various BI tools. The example below was made with Microsoft Power BI directly from these tables.

Weekly OT Distribution

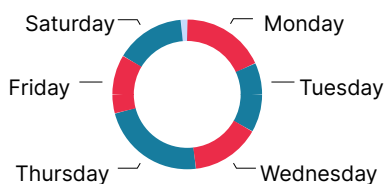

OT vs. Total Hours

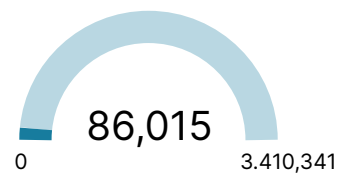

Employees by OT

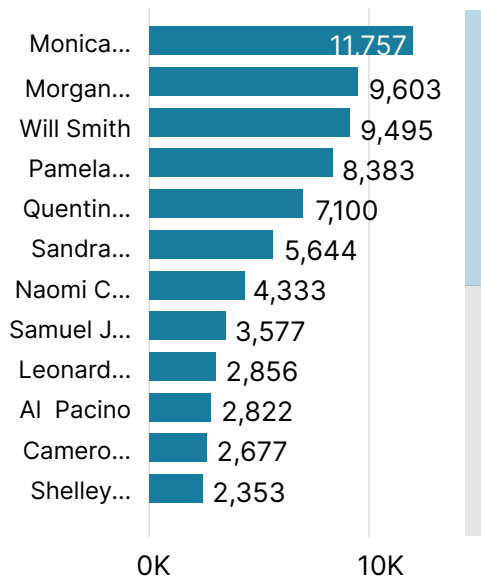

Weekly OT Percentage

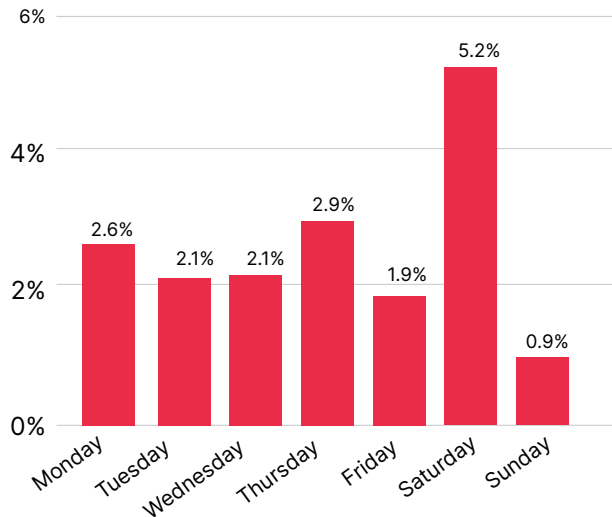

Watch Time&Space video

